

MSR



User Manual

CONTENT

1. Product overview	01
1.1 Introduction	01
1.2 Features	01
1.3 Specification And Performance	02
1.3.1 Parameters	02
1.3.2 Interface Definition	03
1.3.3 Wall-mounted installation instructions	05
1.3.4 Packing list	06
2. Battery Management System	07
2.2 Status Indication	08
3. Communication	09
3.1 Communication instructions	09
3.1.1 Parallel RS485	09
3.1.2 Independent RS485	09
3.2 Parallel wiring method	09
3.2.1 Parallel communication connection method	09
3.2.2 Positive and negative wire connection method	10
3.2.3 Power ON/off sequence	10
3.3 Dial switch settings	11
3.4 interface definition	12,13
4. Battery Use Instructions	14
4.1 Charging	14
4.2 Discharge	14
4.3 Discharge temperature	15
5. Notes for Product Use	15
5.1 Processing	15
5.2 Charging and Discharge	16
5.3 Storage	16
5.4 Processing	16
MSR Lithium Battery warranty.....	17,18
Warranty Claim Process.....	19
Warranty form.....	20

1. Product overview

1.1 Introduction:

The model LiFePO₄ battery pack is designed specifically for energy storage systems, with higher efficiency and higher reliability. With the intelligent battery management system, the intelligent battery detection system. This model of LiFePO₄ battery pack is ideal for off-grid and hybrid utilization, providing a long-term built solution, and has the ability to deploy and use in a variety of scenarios, such as homes, farms, factories, data rooms, hotels, etc.

1.2 Features:

- ★ LiFePO₄ chemicals give batteries a safer performance, longer life and energy density
- ★ The fully intelligent battery management system (BMS) protects the battery pack and the battery from over-discharge, over-charge, over-current, and high/low temperature
- ★ The intelligent monitoring system, which can monitor and download the data to the computer in real time
- ★ The battery comes with a balance function that greatly extends the service life of the battery
- ★ The battery has no memory effect, and can deeply charge and release the battery
- ★ The self-discharge consumption is very small, more than 24 hours without the battery will automatically enter the low power mode
- ★ Environmentally friendly, free of heavy metals and harmful substances, and meets the ROHS requirements
- ★ The battery can be used in parallel for any scenario requiring a large power backup
- ★ Battery do not require active maintenance, one-time purchase guarantees life (assuming you use the right battery and follow the guidelines)
- ★ Cell meets IEC62619, CE standards, and ROHS requirements

1.3 Specification and Performance:

1.3.1 Parameters

Project	Conventional Parameters
Battery Type	LiFePO4
Model	Xtreme-Plus
Configuration	1P16S
Rated Capacity	302Ah
Nominal Voltage	51.2V
Energy	15KWh
Operation Voltage Range	40~58.4V
Maximum charging persistent current	100A
Maximum discharge persistent current	200A
Recommend Charge Current	70A
Communication	RS485 / RS232 / CAN /Bluetooth
Operating Temperature Range	Charge: 0~55°C, Discharge: -20~60°C
Storage Temperature Range	-10~50°C
Dimension (W*D*H)	860*440*265mm
Weight	122±3.0KG
Live Capacity Of Products Shipped	10%-40% Electricity delivery
Packaging Material	Carton

1.3.2 Interface Definition

A) Battery Appearance

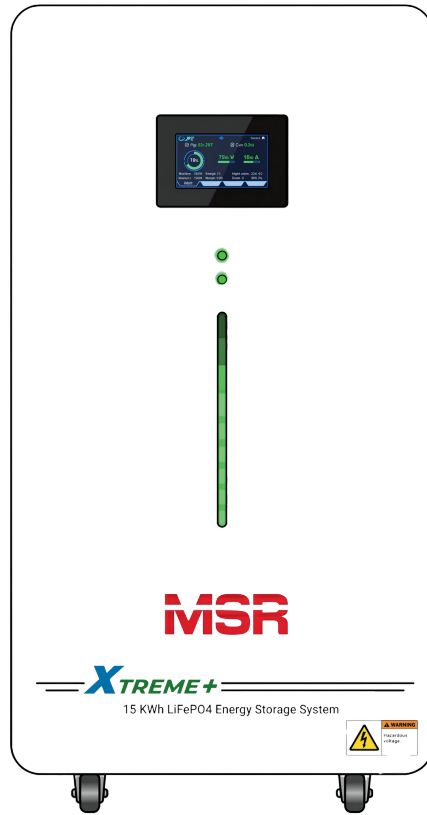

B) Battery Size

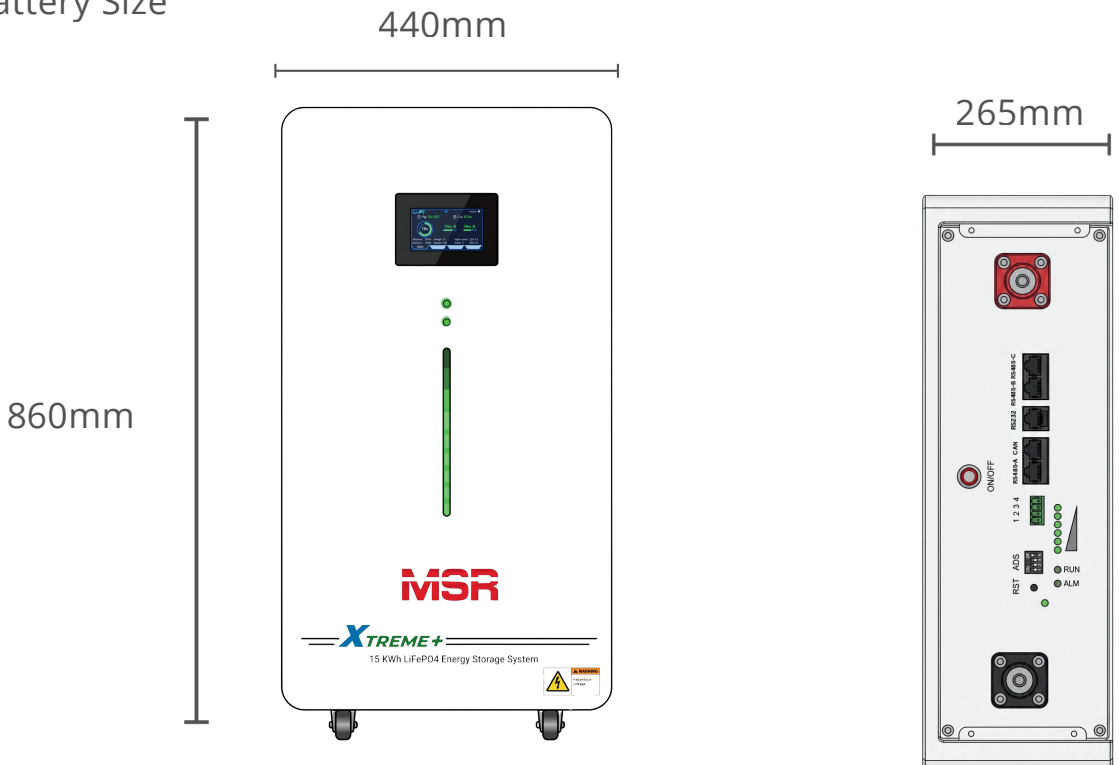

C) Panel Interface Refer To The Following Figure

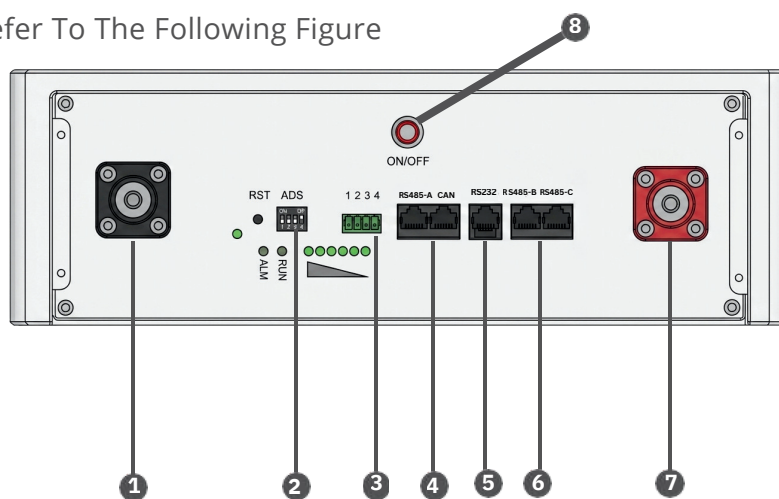

No.	Project	Description
1	NEGATIVE Terminal	A pair of terminals with the same function, one connected device is expanded in parallel with other batteries. For each individual module, each terminal can realize the charge and discharge function
2	ADS	The ADS is a 4-pin DIP switch used to assign a unique communication address to the battery module. It is essential when connecting multiple batteries in parallel, allowing the inverter or master battery to identify and manage each individual module within the system.
3	Dry Contact Point	1 / 2 Open, close when fault protection; 3 / 4 open, low battery power alarm
4	RS485A/C AN	The RS485-A and CAN ports are dual RJ45 communication interfaces designed for high-speed, reliable data transmission between the Battery Management System (BMS) and external networks.
5	RS232	RJ11 interface, used for battery status monitoring
6	RS485B/R S485C	The RS485-B and RS485-C ports are dual RJ45 interfaces specifically dedicated to internal cascade or parallel networking. They enable multiple battery modules to be daisy-chained together, ensuring seamless, real-time data synchronization—such as voltage, temperature, and State of Charge (SoC)—across the entire battery pack system for unified and balanced operation.
7	Positive Terminal	A pair of terminals with the same function, one connected device is expanded in parallel with other batteries. For each individual module, each terminal can realize the charge and discharge function
8	On/Off	The ON/OFF button is a manual reset and power switch used to wake up or shut down the Battery Management System (BMS). Pressing and holding this button manually activates or deactivates the battery's internal circuitry, allowing for safe installation, maintenance, or long-term storage without accidental power output.

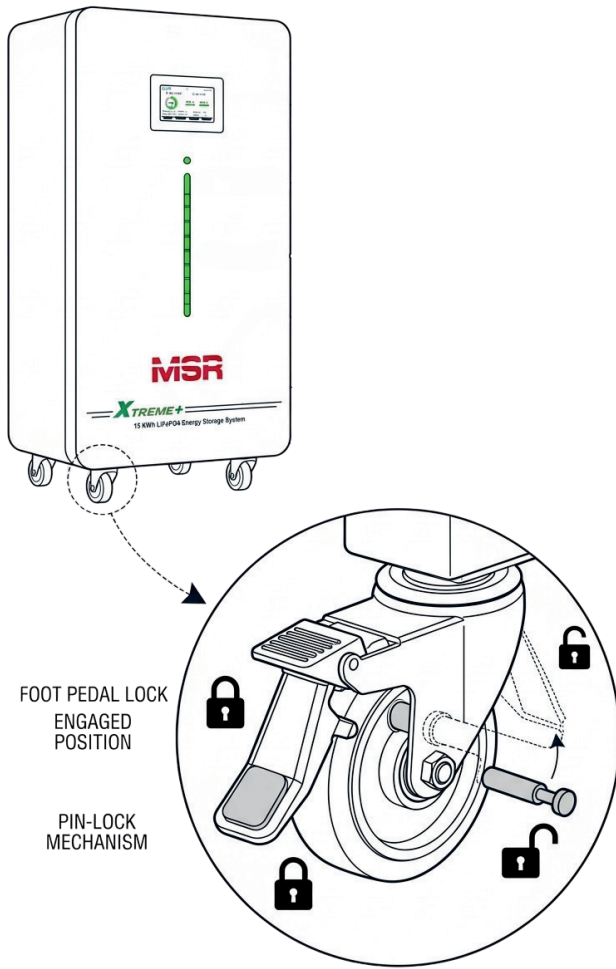



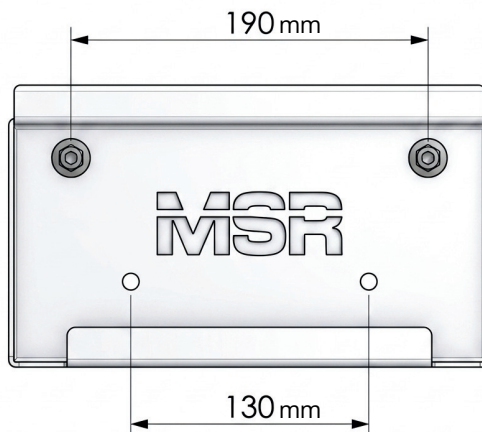







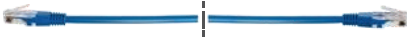

Use the M6*50 Expansion screws from the accessories to mount given wall mount onto wall



1.3.4



Packing list

Project	Description
	Main unit *1
	Battery negative terminal cable *1
	Battery positive terminal cable *1
	Battery to Battery parallel communication cable *1
	Battery to Inverter Communication cable *1
	USER MANUAL*1
	Warranty Card
	M6*50 Expansion screw *8
	Wall Mount
	Terminal Covers
	Dry Contact
	Terminal Screws
	Earthing Screws

2. Battery management system

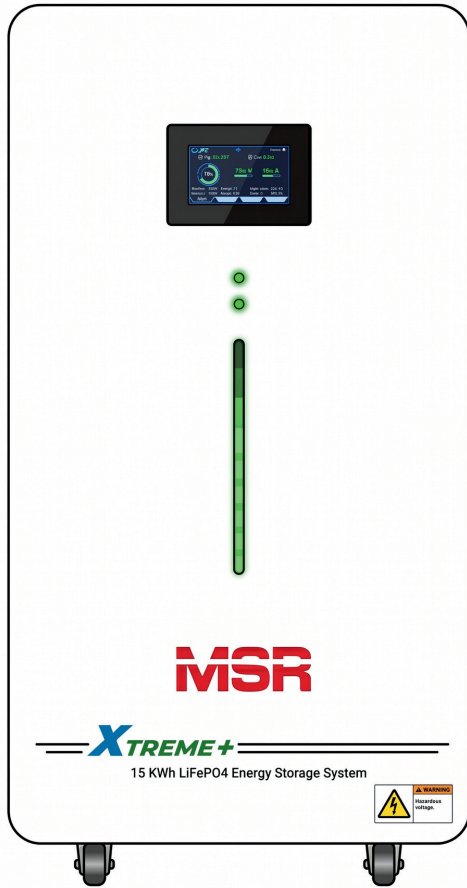
2.1 Description of the LED indicator light



-  **System Status LED (RUN/Fault)**
Color-coding LED is steady:
Green = Run
Blue = Charging
Red = Fault/Alarm
-  **Alarm LED (normally OFF)**
Turns Red, onsing Red for alarm conditions
-  **Bottom LED Bar**
SoC (State of Charge) Bar Indicator (0% to 100%)

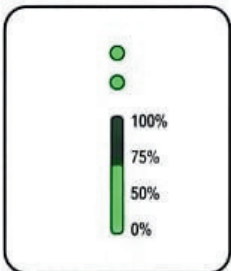

STANDBY
Top LED steady Green,
SoC bar steady Green
(shows current level)

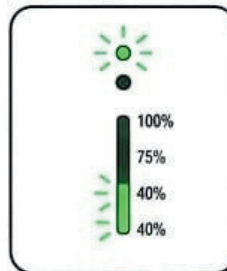

DISCHARGING
Top LED flashing Green,
SoC bar flashing Green
(shows current level)

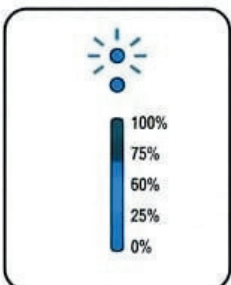

CHARGING
Top LED flashing Blue,
SoC bar **running**
(chasing) Blue (shows
current level and
charging progress)

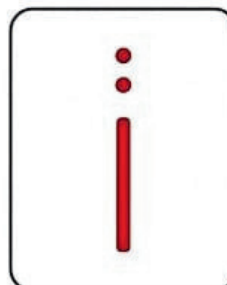

FAULT / ALARM
Top LED, Alarm LED,
and full SoC bar turn
solid Red

2.2 Status indication

Stand By		Charging				Discharge			
Capacity indicator light		L4●	L3●	L2●	L1●	L4●	L3●	L2●	L1●
Quantity of electricity	0%~25%	OFF	OFF	OFF	Flashing2	OFF	OFF	OFF	ON
	25%~50%	OFF	OFF	Flashing2	ON	OFF	OFF	ON	ON
	50%~75%	OFF	Flashing2	ON	ON	OFF	ON	ON	ON
	75%~100%	Flashing2	ON	ON	ON	ON	ON	ON	ON
Run The Indicator light, the●		ON				Flashing 3			

3. Communication

3.1 Communication instructions

3.1.1 ParallelRS485

Equipped with dual RS485 interfaces, Can view battery information, The default baud rate is 9600bps. To communicate with monitoring equipment through RS485, Monitoring equipment as host, Polling data based on address, Address setting range is 2-15.

3.1.2 IndependentRS485

Independent RS485 interface, The default baud rate is 9600bps, This interface is used for communication with inverters, When this battery is the main unit, Can summarize slave data and communicate with inverters.

3.2 Parallel wiring method

3.2.1 Parallelcommunicationconnectionmethod

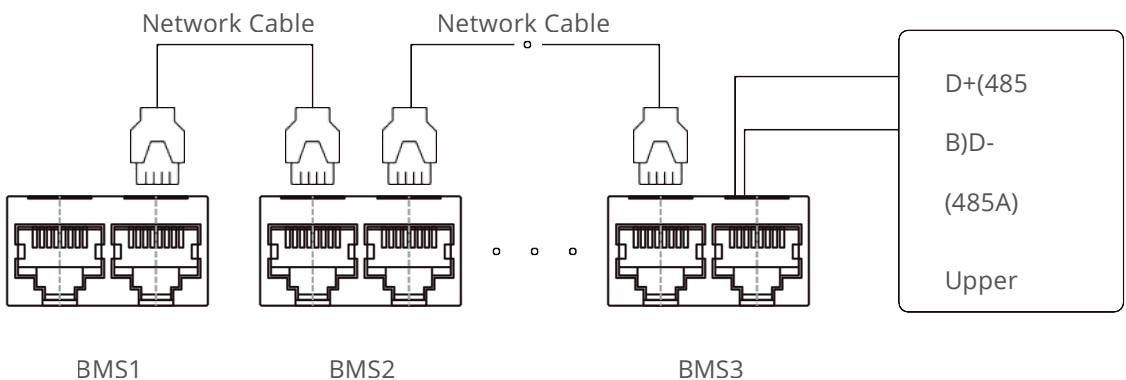

3.2.2 Positive and negative wire connection method front view

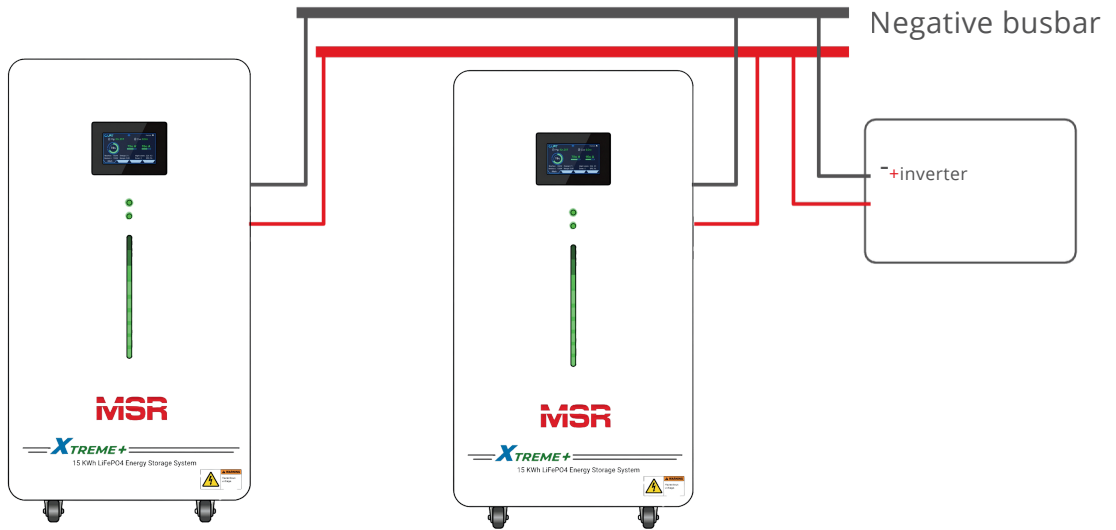

side view

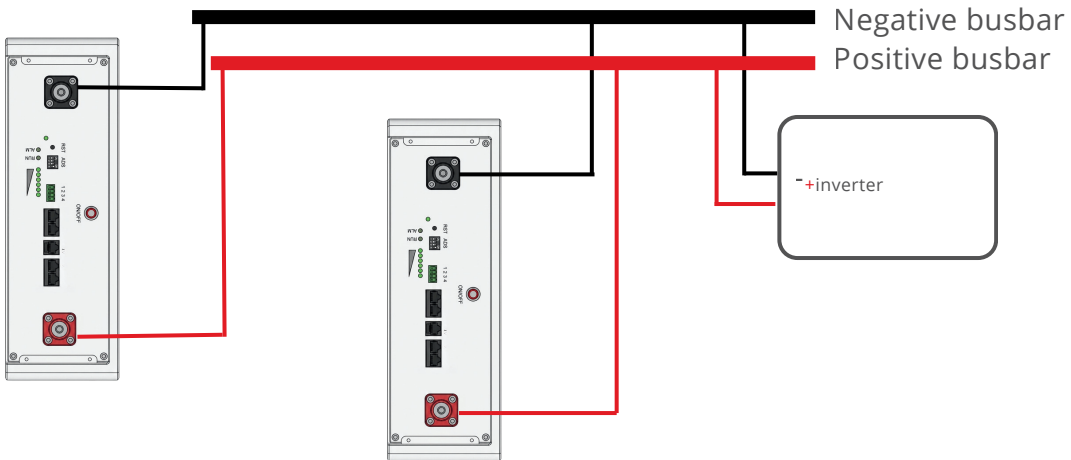

★ Ensure before parallel connection circuit breaker in "OFF" state.

★ Suggested installation spacing: $\leq 200\text{mm}$

3.2.3 : Power ON/off sequence

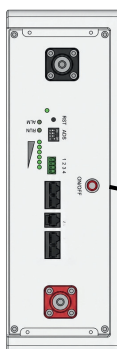

Press the Switch button (SW) on equipment

3.3 Dial switch settings

When batteries are used in parallel, Different batteries can be distinguished by setting the address through the dial switch on the BMS, Refer to the table below for the definition of BMS dial switch:

The default dialing address is '1' for the host, '2-15' is the slave machine;

Host Battery "RS232" communication interface and inverter connection;

Parallel operation of two or more battery packs, Dial switch reference address "1+2", "1+2+3", By analogy with this method...



0	1 2 3 4	4	1 2 3 4	8	1 2 3 4	12	1 2 3 4
1		5		9		13	
2		6		10		14	
3		7		11		15	

3.4 Interface definition

(1) Interface diagram

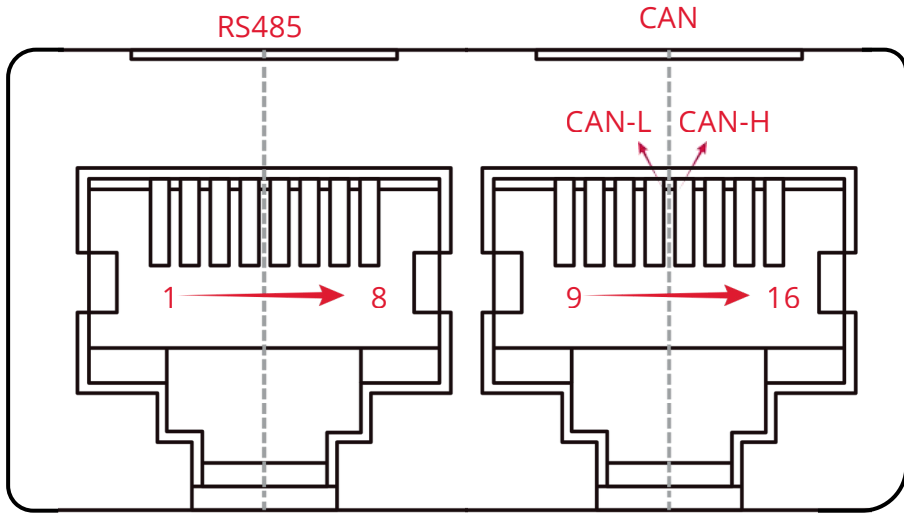

RS485 and CAN interfaces

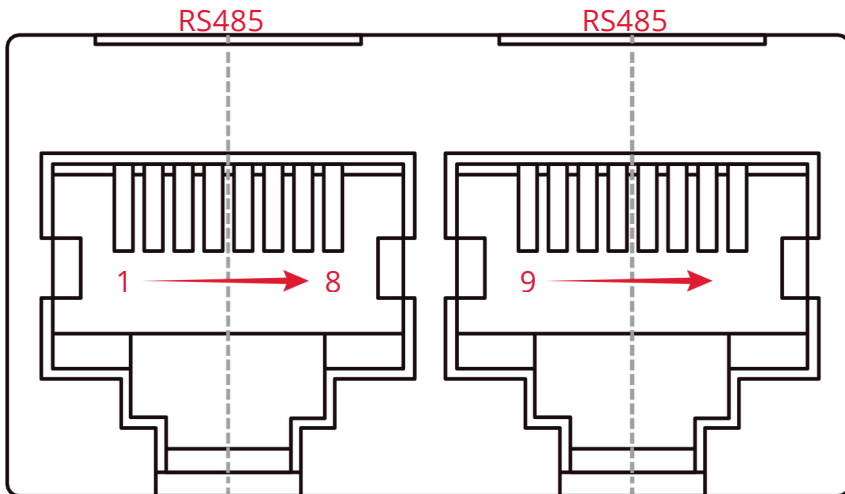

Parallel communication port

RS485--Adopting 8P8C vertical RJ45 socket	
RJ45 pin	Definition Description
1,8	RS485-B1
2,7	RS485-A1
3,6	GND
12, 13	NC

RS485 interface

RS485--Adopting 8P8C vertical RJ45 socket	
RJ45 pin	Definition Description
1,8	RS485-B
2,7	RS485-A
3,6	GND
4,5	NC
9,16	RS485-B1
10, 15	RS485-A1
11, 14	GND
12, 13	NC

Parallel communication port

4. Battery Use Instructions

4.1 Charging

- ★ Charging current: cannot exceed the maximum charging current specified in this specification
- ★ Charging voltage: shall not exceed the maximum charging voltage specified in this specification
- ★ Charging temperature: The battery must be charged within the ambient temperature range specified in this specification
- ★ The battery adopts constant current and constant pressure charging mode, and forbids reverse charging. If the positive electrode of the battery meets the negative electrode in the opposite, it will damage the battery

4.2 Discharge

- ★ Discharge Current: the discharge current shall not exceed the maximum discharge current specified in this instruction. Excessive current discharge will reduce the battery capacity and cause the battery to heat up.
- ★ If the battery enters over discharge protection, it should be charged within 3 days. If it could not be charged in a timely manner, all connections on the battery must be disconnected.

4.3 Discharge Temperature

★ Battery discharge must be within the temperature range specified in this specification. Immediately charging after a short time of excessive discharge will not affect the use, but a long time of excessive discharge will lead to the loss of battery performance and battery function.

If the battery is not used for a long time, it may be in a certain discharge state due to its self-power consumption characteristics. In order to prevent the occurrence of over discharge, the battery should maintain a certain amount of electricity.

5. Notes For Product Use

5.1 Warnings

★ Do Not Put The Battery Into The Water Or Wet It.

★ Forbids Charging And Using The Battery Outside Our Specified Temperature Range; Do Not Store, Charge, And Use The Product Near The Fire Sources Or Heat Sources.

★ When The Battery Pack Emits An Odor Or Leakage, It Should Immediately Stop Using Or Stop Charging, And Move To The Open And Ventilated Place, Stay Away From The Fire Source, And Contact Us In Time.

★ The Optimal Service Temperature Of Products Is $25 \pm 5^{\circ}\text{C}$, If The Product Is Not In This Temperature Range During Use.

★ Load Use, Do Not Connect Positive And Negative Poles.

★ Do Not Short-circuit The Positive And Negative Electrodes Of The Battery Pack With A

Metal Conductor.

★ Do Not Fire The Battery Pack Or Heat It.

★ It Is Strictly Prohibited To Dissect The Battery Pack, Puncture The Battery Pack With Nails Or Sharp Objects, Use Hammers Or Other External Forces, And Trample Or Fall The Battery Pack.

★Strictly Prohibited Putting Battery Packs In A Microwave Or Pressure Vessel.

5.2 Charging and Discharge

★ The Battery Must Be Charged Using An Appropriate Charger.

★ Do Not Use A Modified Or Damaged Charger.

★ During Charging And Use, Please Stop Charging And Using It Immediately.

5.3 Storage

★Store The Battery In A Cool, Dry, And Well-ventilated Place. If More Than Three Months Of Long Storage, It Is Recommended That You Should Charge The Battery Extra.

5.4 Processing

★ Different Countries Have Different Regulations, Please Handle According To The Local Regulations.

If There Is Any Fault Or Abnormality During Use, Please Contact Us And Do Not Remove The Battery Pack Without Permission.

MSR Lithium Battery warranty

This limited warranty covers the MSR Rechargeable Li-ion Battery models:

This warranty does not include any accessories and tool kit items provided along with the product.

This warranty only covers the repair or replacement of a defective product. The repaired or replaced product will continue the original remaining warranty period. In either case, it shall not justify as a renewal of the warranty period.

The warranty continues for a certain period of years from the earlier of: 1.The date of installation of the Product; or 2.Six (6) months after the date the Product was manufactured.

Warranty conditions

1. The battery is intended to be used indoors only. Outdoor use will render the warranty void.
- 2.The batteries must have not be contaminated with any foreign corrosive matter.
- 3.The warranty does not cover the damage due to neglect or abuse such as improper installation, freezing, fire, flooding, or any acts of nature.
- 4.The warranty does not cover surges or spikes from the inverter or charging device that could damage the battery.
- 5.If the battery or batteries were not installed correctly and not according to the manual with correct settings, it could result in damage. Incorrect installation and setup will invalidate the warranty.
- 6.Batteries must be provided with a refresh charge every 5-6 months, while in storage, prior to final installation.

7.Warranty will be void if the firm ware or BMS on the device has been deliberately tampered with to try and reset cycle values or any data for warranty evaluation purposes.

8.If it is found that the battery is being overloaded through large current draws outside of the intended specification parameters (100Amps), it will lead to the warranty being void.

9.The warranty is non-transferable, and only applies to the original purchaser of the equipment.

10.The warranty will be void if the serial number has been tampered with or has been removed from the device.

11.The battery will not be considered effective unless it fails to deliver 50% or less of its rated capacity during claimed warranty period.

12.If the battery is interconnected or mixed with other non-MSR batteries the warranty is void.

13.Warranty will be void if the installation or commissioning has not been performed by an Professional Installer

14.In the event that the battery needs to be relocated it must be disconnected, moved and re-installed by an professional installer.

15.The operating temperature for the battery is designed to be 0 to 50 degrees Celsius, however, it is recommended to keep the battery below 25 degrees Celsius to maximise the design life and life cycle of the battery. The cycle life cannot be guaranteed if the battery is operated in temperatures exceeding 25 degrees Celsius.

Warranty Claim Process

In the event of a possible warranty claim, the following steps should be taken:

1. Claims under this warranty must be within 48 hours of a defect being discovered, notification must be provided to the approved re-seller of a claim.
2. The end user must submit the invoice for the procurement of the Product to the approved re-seller indicating date of delivery.
3. The reseller must send or arrange with the end user to send the battery to one of our service centres.
4. The service centre will evaluate the battery and validate if a claim is substantiated.
5. If a claim has been validated, repair and servicing of the battery will be performed.
6. Any replacement parts will become the property of MSR
7. It is for the client to arrange delivery and collection of the unit. If the client wishes to dispute to final evaluation decision, the product must be evaluated by a certified 3rd party testing company. You will bear the cost of any 3rd party evaluation service charge. (Unless your claim is proven to be valid, in which case MSR will be responsible for the testing costs)

If any testing of the Products capacity is required, the testing must occur in the following conditions:

- a) The test is based on a single module.
- b) The ambient temperature of the Battery Module must be $[25^{\circ}\text{C}\pm 2^{\circ}\text{C}]$.
- c) The initial temperature of the battery modules pods must be $[25^{\circ}\text{C}\pm 2^{\circ}\text{C}]$.
- d) 50A constant current charge to 3.65V for cell, then switch to constant voltage (58.4Vdc), charge until charge current declines to 5A.
- e) Constant current (50Amps) discharge till all the cell voltages are below 2.70Vdc.

Warranty Form

Note: Signature or Seal stamp required.

MSR shall have no obligation for unqualified application such as incorrect information or missing necessary information.

Product Model		Serial Number (S/N)	
Company Name			
Contact Person		Contact Number	
Contact email			
Company Address			
Replacement Deliver Address			
Name of End user			
Date of Installation			

Fault Description

Warranty Authorized signature!

The following information must provide after faulty battery been replaced
Replacement Information.

ProductModel		SerialNumber(S/N)	
Replacedby		ReplaceDate	

Replacement Information Authorized signature:

MSR
MSR

www.powerbysr.com